



Water Polo Field of Play

Official FINA equipment – the number one choice for water polo – Made by Malmsten in Sweden.

Field of play, made to measure, using the racing lane line technology* to create a fair boundary of play for water polo.

Appreciated by players, coaches and referees worldwide.

Field of play consists of two field lines, 8 goal lines and 2 short

**water turbulence control*

Unique qualities:

- Durable
- Wave reducing
- Installed to precision
- Easy to maintain



1510001 – Field Line; indicating field length

1510002 – Goal Line; fixating free floating goal, framing re-entry area

1510003 – Re-entry; short Lane Line 1008 mm or 800 mm, boxing the re-entry area

Goals sold separately

Product description:

Wave reducing field of play made with Ø 100 or Ø 150 mm line

A high quality commercial field of play made to fit boundaries of field, normally 30x20 m for men and 25x20 m for women. Can be customized to any pool size.

Selected When it Counts

Associated products



1511003 WP Goal, Senior, 3000 mm, Official FINA



1511004 WP Goal, 2500 mm, according to FINA rules



1011023 Spring Cover



1514007 Ball release



1515003 Catwalk WP



1514001 Field Marking Matting



1515001 Advertising Float



1514008 Underwater Eyelet



1514011 Cones



1514021 Cones – Water Polo Field Line



1514014 Team Bench



1514009 Ball holder for judger



1514008 Set of referee flags



1512001 Water Polo Allsport 1200 Basic



1513003 Water Polo Countdown stand-alone



2010003 Wall/Bottom Anchor



1011021 Lane Line Slider



2010004 Lane Rope Trap

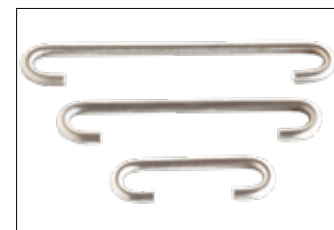

1011007 Extenders Malmsten for Racing Lane Lines



2010010 Floor Anchor for Lane Line Post
1013001 Lane Line Post



1012001 Storage Trolley for Lane Line Malmsten
1050006 Cover for Malmsten Storage Trolley



1011001 Storage Bag for Racing Lane



1011002 Ratchet Wrench for Take-up Reel

Selected When it Counts

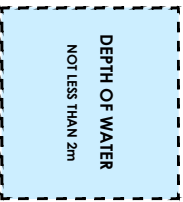
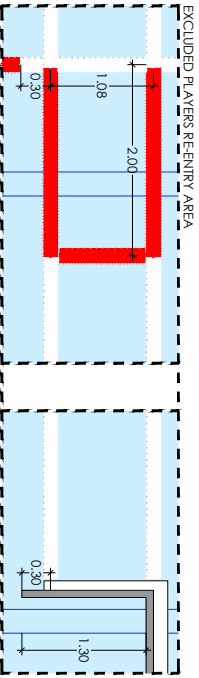
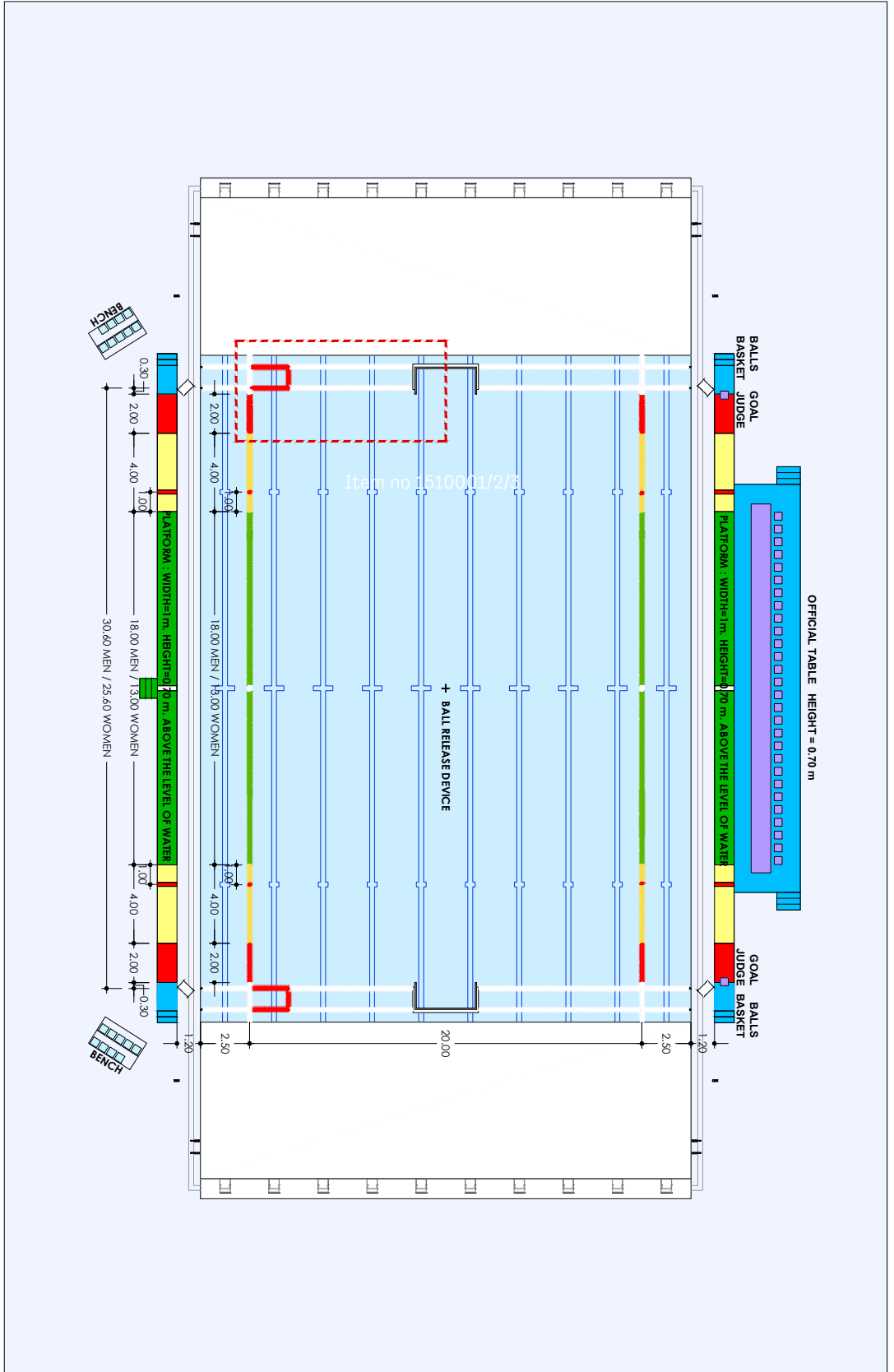

**FIELD OF PLAY FOR OLYMPIC GAMES AND
WORLD CHAMPIONSHIPS
WATER POLO**

ANNEX

WP 1

Selected When it Counts



Coat Rack with Bench

Sturdy movable coat rack with bench, especially designed for Malmsten for water polo games and training.

A handy and mobile rack that is perfect to place on the pool deck, one at each end of the field, during water polo games and training. Designed especially for players' bath robes and supplies. With its 6 slats it is also comfortable to use as sitting bench. Slats allow for quick water drainage.

The rack is equipped with 8 double hangers, a bench with a shelf underneath and a top shelf. Easy to move around with its 6 castor (4 lockable)



Product description:
2000 x 570 x 1900 mm

Seat height: 450 mm

Free space between seat and top shelf 1400 mm

Selected When it Counts



Referees' structure Catwalk - Upgrade

Effective March 1st, 2019, there is an amendment to the existing FINA water polo rules. In short, the new rule requires the yellow field to increase from 3 m to 4 m each side, with a red line - to mark foul throws - (at 3m of this 4m) at 5m from goal line.

We offer easy to use upgrade kit for matting on Malmsten referee's catwalk, consisting of 4 pieces of yellow matting 0,9x1m with red matting 0,1x1m adapted for the referee's catwalk.

This matting may be fixed with carpenters glue, which is not included in this kit.

Unique qualities:

- Official FINA
- Top of the line
- Commercial design aluminium structure
- Solid and water resistant
- Marine grade plywood
- Excellent anti- skid cover treated against dirt and bacteria built-up
- Storage boxes on wheel (sold separately)



Product description:

Yellow Carpet with red foul throw mark
 Size: 4 x 1m sections
 Color: yellow 0,9x1m and red 0,1x1m
 Information:
 Sold Per Kit

Selected When it Counts

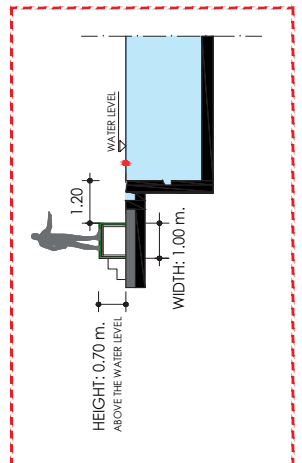
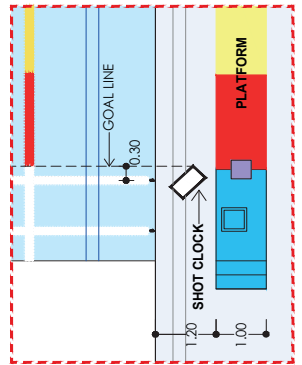
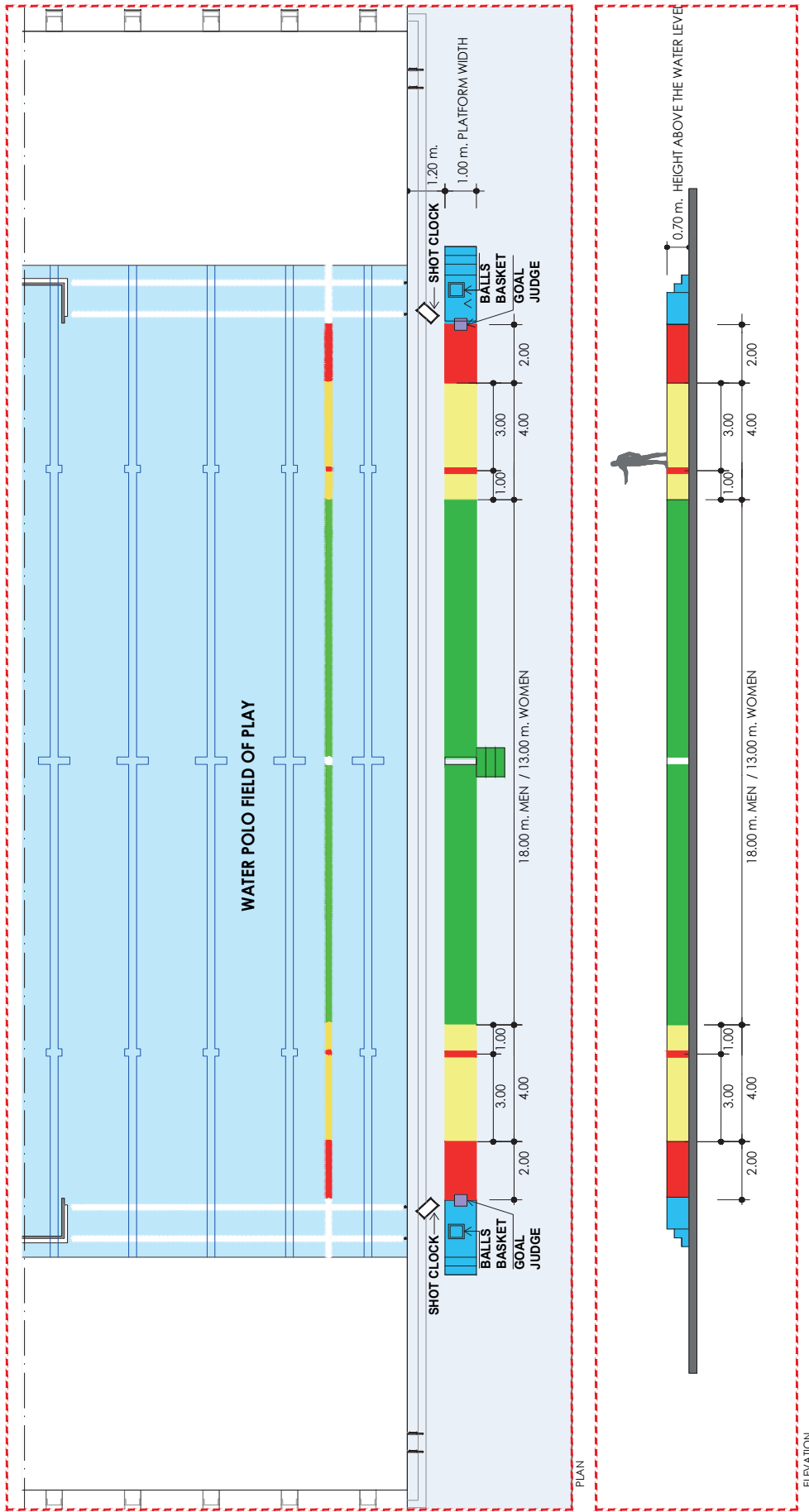

	PLATFORMS FOR OLYMPIC GAMES AND WORLD CHAMPIONSHIPS WATER POLO	
	ANNEX	WP 2



WP Field with Goals 2150 mm – Portable/Inflatable

This complete set includes field of play 20x15 m (adjustable to 20x11 m) together with two goals 2150 mm (2150x750 mm).

Official HabaWaba equipment U9 and U11.

Portable and easy to move and store. Packed in three bags

Product Specifications:

Goal width: 2150 mm

Goal height: 750 mm

Field: 20x15 m

Made of reinforced PVC

Shipping measurements:

1. 700x500x350mm (2 goals), 20kg.

2. 500x400x370mm (half field), 9,5kg.

3. 500x400x370mm (half field), 9,5kg.

Included:

3 Sport bags, 2 Medium pumps, Repair kit, Back-up valve, 2 Rubber ropes with hook

Our products are non toxic and green for the environment.

Unique Qualities:

- FINA and LEN standards
- Great for Waterpolo Clubs
- Great for Pool and Ocean Play
- Portable and easy to move and store
- Easy Quick Inflate / Deflate Valve
- Easy to maintain and use
- Auto Lock Valve System

Selected When it Counts



Referees' structure Catwalk

The Malmsten catwalk is a flexible system, easy to install and to put away after the competition.

The catwalk has the length of the field of play for water polo and is 1 m wide and 0,7 m in height. It is an easy hook-on system. For major championships, one catwalk is required along each side of the field of play (sold per unit).

The catwalk has the color markings of the field of play. The color-coded matting is an easy roll-out carpet according to FINA revised rule, effective March 2019, and comes with an add on to inter-change between field of play men and women.

Easy conversion from men to women marking by pulling the 2 yellow pieces inwards (to indicated position 25 m). The catwalk can be delivered in Lockable Storage boxes on wheels (sold separately). Art. nr. 1514010

This platform may be used for other activities around the pool.

Unique qualities:

- Official product for LEN and FINA
- Top of the line
- Commercial design aluminium structure
- Solid and water resistant
- Marine grade plywood
- Excellent anti- skid cover treated against dirt and bacteria built-up
- Easy hook-on system. Lockable
- Storage boxes on wheel (sold separately)



Product description:

Dimensions:

Total length: 32 m + stairs = 33,6 m

Height: 0,7 m Width: 1,0 m Length/Section: 2 m.

2 short steps at each end (2 x 0,5 m steps)

Matting:

1 x 18 m green with white centre mark
2 x 4 m yellow (with red fowl line), 2 x 2 m red, 2 x 1 m blue
2 x 2,5 m blue matting is included for converting to women's field of play (There is no matting on the stairs)

Sold per unit

Selected When it Counts

Technical information

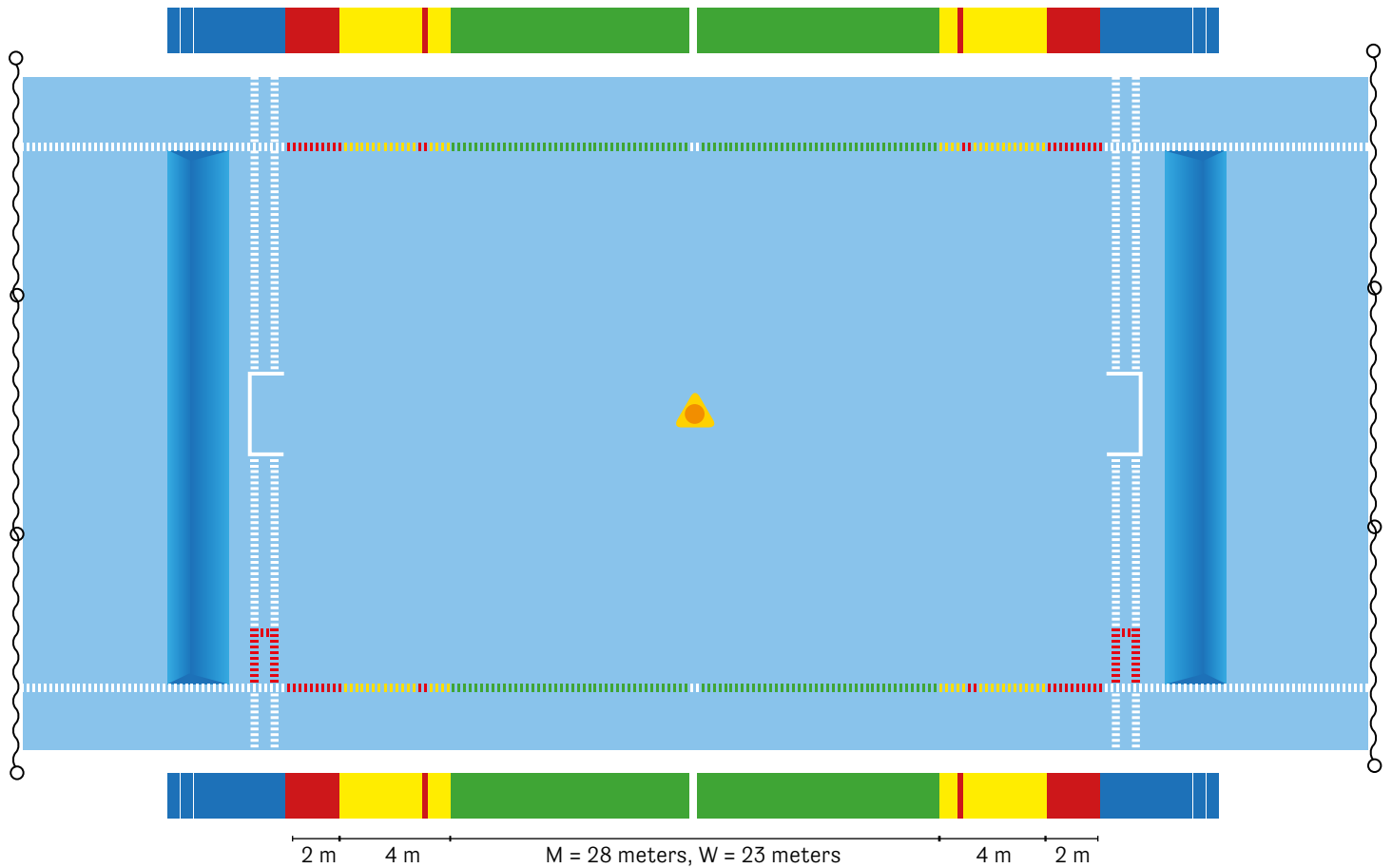

- 1 complete catwalk is stored in 4 boxes on wheels. A total of 8 storage boxes for the 2 complete catwalks.
- For one pool, the 4 boxes are marked with 1 and 2, where 1 & 2 should go on one long side of pool and the other 1 & 2 on the other long side of pool.

- Before storing in boxes; hose off with clean water, wash dirt with luke-warm water and light soap. Let dry. Wipe the boxes.
- Keep in well ventilated area and out of direct sun light. Do not keep boxes outside when raining.

Associated products



1514010 Transportation and storage boxes for the catwalk elements



1514009 Ball holder - for goal judge

Selected When it Counts

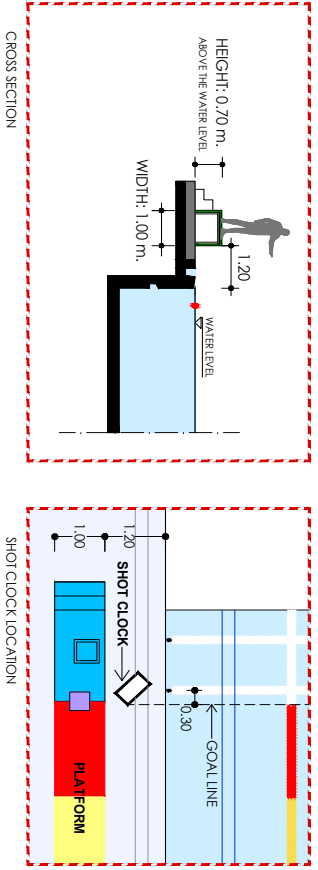
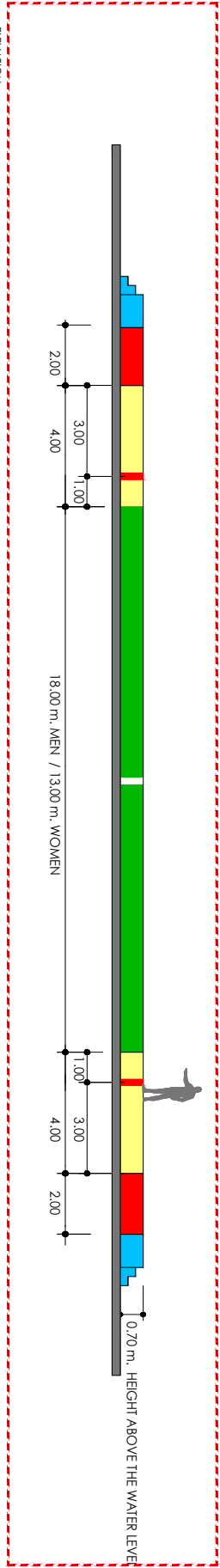
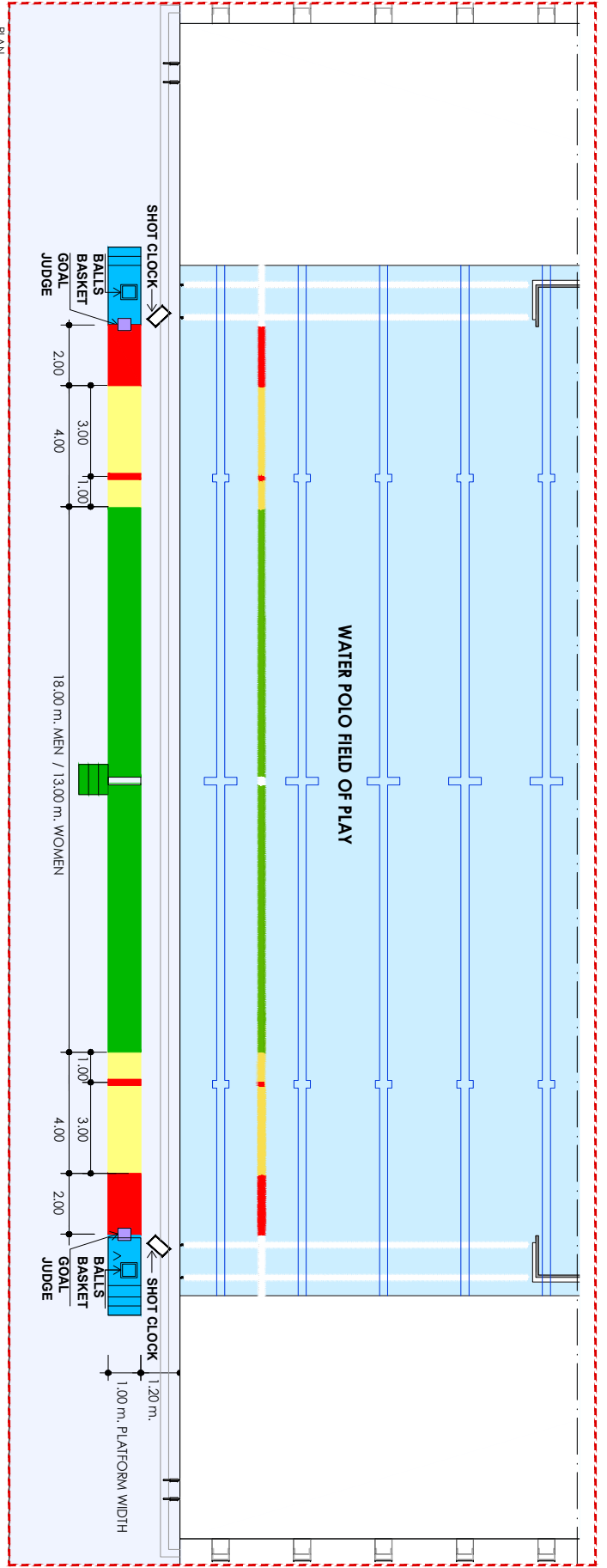

	<p>PLATFORMS FOR OLYMPIC GAMES AND WORLD CHAMPIONSHIPS WATER POLO</p>
<p>ANNEX</p>	<p>WP 2</p>



Advertising structure for aquatic use

For water polo field of play; diving or synchronized swimming partition

Advertising structure in 4 parts, each 9,9m, inflatable and perfect for aquatic use.

Place for advertising banners on front and back.

Easy affixing of advertising banners (not included) on pre-sawn velcro.

Arrives with electric pump and may be transported easily.

Unique qualities:

- Strong plastic-treated trevira material
- With Velcro front for banner placement
- Easy inflated and deflated
- Comes in bags for storage and protection

Product description:

Material: Strong plastic-treated trevira material

Dimensions: 4 x 9,9 m (Length), Base: 1650mm, Height: 1000 mm

Information: Sold Per Set (4 units) Including one electric pump.

Important:

Electric pump is required – attention to not to use electric pump near water.

Usage instructions have to be followed, valves may not be opened. Air is pumped in or sucked out using the pump.



Selected When it Counts



Advertising structure for aquatic use

Useful information

- Advertising inflatable structure consisting of 4 units 9,9m x 1,65 x 1 m. With place for approximately 6, 12 or 18 banners the width of 0,7 m per structure.
- Be careful when opening storage boxes and handling the equipment. A cutting knife, sharp corners or dragging on pool deck may damage the unit.
- To inflate or deflate use pump and do while equipment is out of water.
- To inflate: 1. Close the zipper. 2. Unscrew the plug. 3. Push in the valve. 4. Place pump and blow in air. It should normally take about 30minutes for 1 structure. 5. When finished - screw back the plug.
- Place advertisement banners while inflated. It is possible to place two in front and one on the back.
- Place inflatable structure in pool water. You may attach with rope to pool deck, or use the suction plugs (8 units are included).
- When finished using - carefully remove from pool. Attention to that any sharp edge may damage the PVC. Rinse with clean water and let dry.
- When fully dried - deflate units.
- To deflate: 1. Open the zipper. 2. Unscrew the plug. 3. Use the "air-intake" side on the pump.
- To fit back into storage box it is crucial to tightly roll and fold the structure.
- Important - never touch the safety valves! These are used to automatically deflate unit when need be.
- In case of air leakage through a small hole - wipe area dry and affix repair sheet (included) with suitable glue for PVC (not included).
- Banners: approximately 6, 12 or 18 banners (per 20m structure) of 0,7 m width should be made with male 5cm Velcro straps on top and bottom. Attention: The Velcro on the inflatable structure is female.



Cones Water Polo Field Line

A set of 14 cones to be fitted onto the water polo field lines.

Manufactured in soft EVA-foam and easily affixed onto the field lines (100mm in diameter).

Unique qualities:

- Easily attached
- Can be used indoor and outdoor



Product description:

Material: EVA Foam

Dimensions:

Height: 31 cm, Width: 16 cm, Depth: 7 cm

Sold per set of 14

(2 White, 4 Yellow and 8 Red)

Selected When it Counts



Lockable Cart for Stop Net

Protective stop net on movable cart may be installed where it is most needed; behind water polo goals to hinder balls from going any further. Net may be stored on cart when not in use, and may be moved to storage area. Protective net is 25m long and 2,5m high.

Movable cart, lockable, with net 25x2,5m, for storage of net (when not in use) and for installing of protective net (where it is needed).

Lockable wire-winch for positioning of protective net, when in use.

Unique qualities:

- Movable cart with net – ready to be used
- Lockable in position
- Safety wire in back of structure
- Sturdy construction

Product description:

Height: 2,5m

Including ss wire (27m), wire-winch (lockable – maximum tension 150kg), protective net (25x2,5m) and equipped with affixing wire in back (for safety).

Weight: 540kg

4 swivel castors (2 lockable with “brake”)

Stainless steel, painted white for corrosion protection

Important:

It is required to affix the counter-weight wire in back of cart so that it may not be tipped over in use or in storage.

When not in use, store in well ventilated area out of direct sun.

Selected When it Counts

Technical information

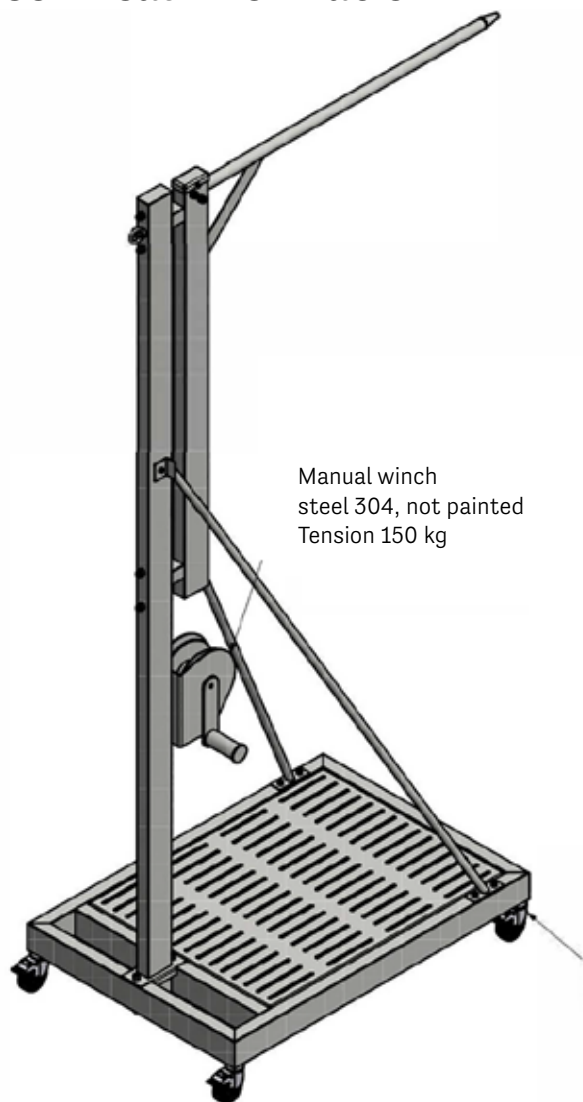

Manual winch
steel 304, not painted
Tension 150 kg

Swivel castors on the mandrel 080
with brake and swivel
The body of stainless steel wheels
made of polyamide 4 pcs.

Accessories Sold Separately:



2010003 Wall-/Bottom Anchor



1511003 Water Polo Goal Malmsten,
free-floating



1510001/2/3 Water Polo Field of Play



Water Polo Team Bench

A well proven team bench, suitable for water polo competitions.

Stable construction made for the harsh pool environment.

Developed with excellent anti-skid surfaces and 10 polypropylene seats.

Capacity: 10 seats



Product description:

Corrosion resistant – made from aluminum. Powder coated aluminum profiles and rifled aluminum plates. Welded construction where the load is greatest. Seats in blue polypropylene with UV-protection

Shipping dimension (bench dimension):

3010x1300x1420mm
Made in accordance with FIFA/UEFA requirements

Unique qualities:

- Proven design
- Made to last; Stable and sturdy construction
- Made for the pool environment; aluminum
- Excellent anti-skid
- Pre-assembled

Selected When it Counts



Transport and Storage Box

The construction of this multi-transport box fulfills all requirements for storing different parts of the catwalk

The housing is made from 10 mm birch plywood and protected with aluminium edges and large rounded metal corners. Robust butterfly closures with no less than two rubberised handles on each side of the case to maximize the carrying efforts of many hands.

Unique qualities:

- Easy-open hinged top
- Ball corners and aluminium edges
- 2 rubberised folding handles on each side
- 4 bottom rollers



Product description:

Dimension: 225 x 135 x 110 cm (WxHxD)

Important

4 Transportation and storage boxes are needed for the catwalk elements.

Selected When it Counts

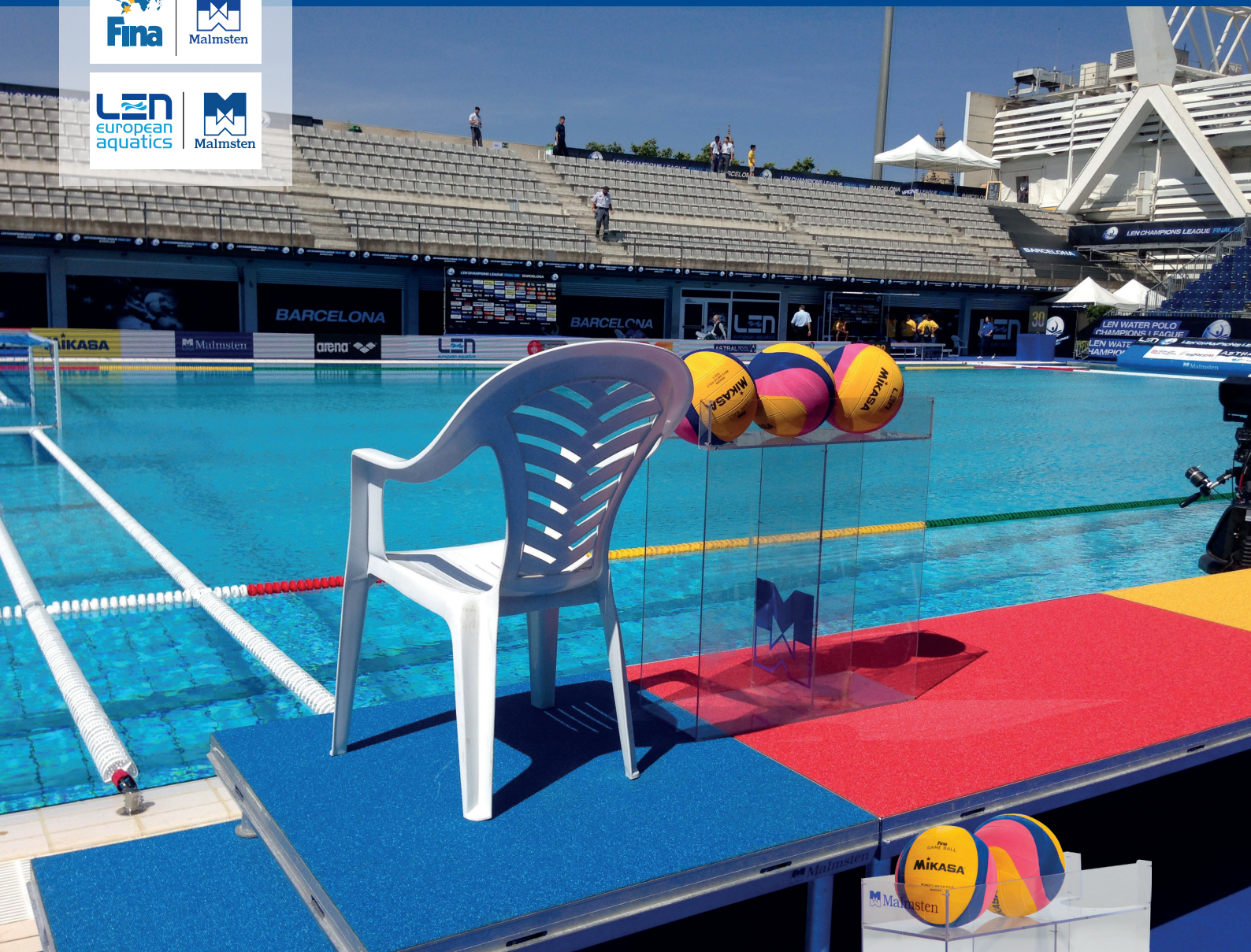

Water Polo Ball Holder – for Goal Judges

Official FINA equipment

Ball holder to be placed next to goal judges on water polo referee's catwalk

Selected by FINA and LEN for all major competitions

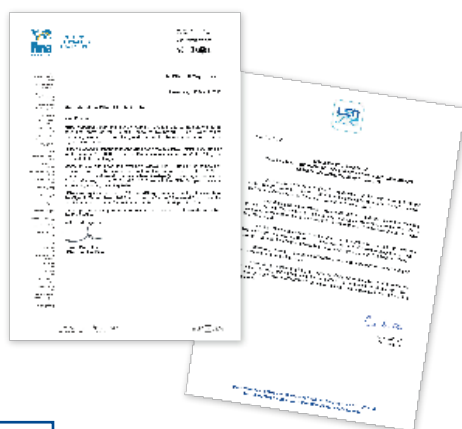

Product description:
Material: Polycarbonate.
Measurements: 650 x 240 x 750 mm.

Unique qualities:

- Holds up to 3 balls
- Stable
- Clear and see-through design

Selected When it Counts

Associated and alternative products

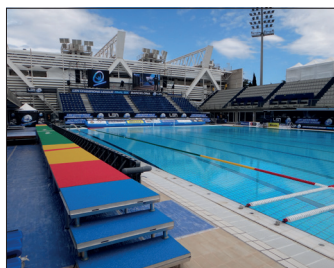

1515003 Referees' structure
Catwalk

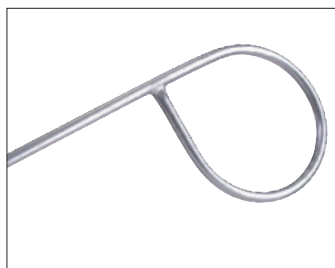

1311001 Reach Pole



1512001 Water Polo Balls



1512002 Water Polo Balls

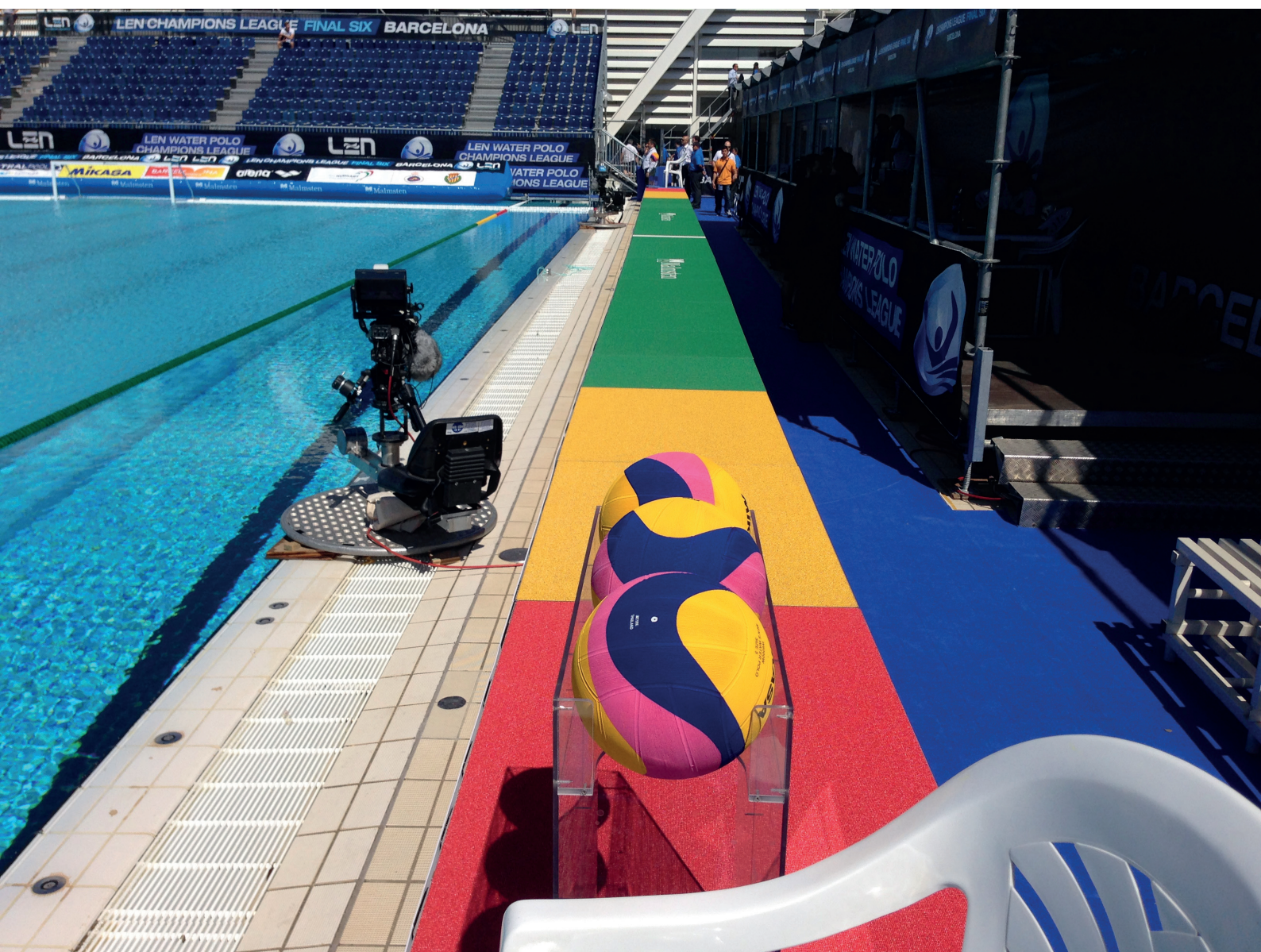

Selected When it Counts

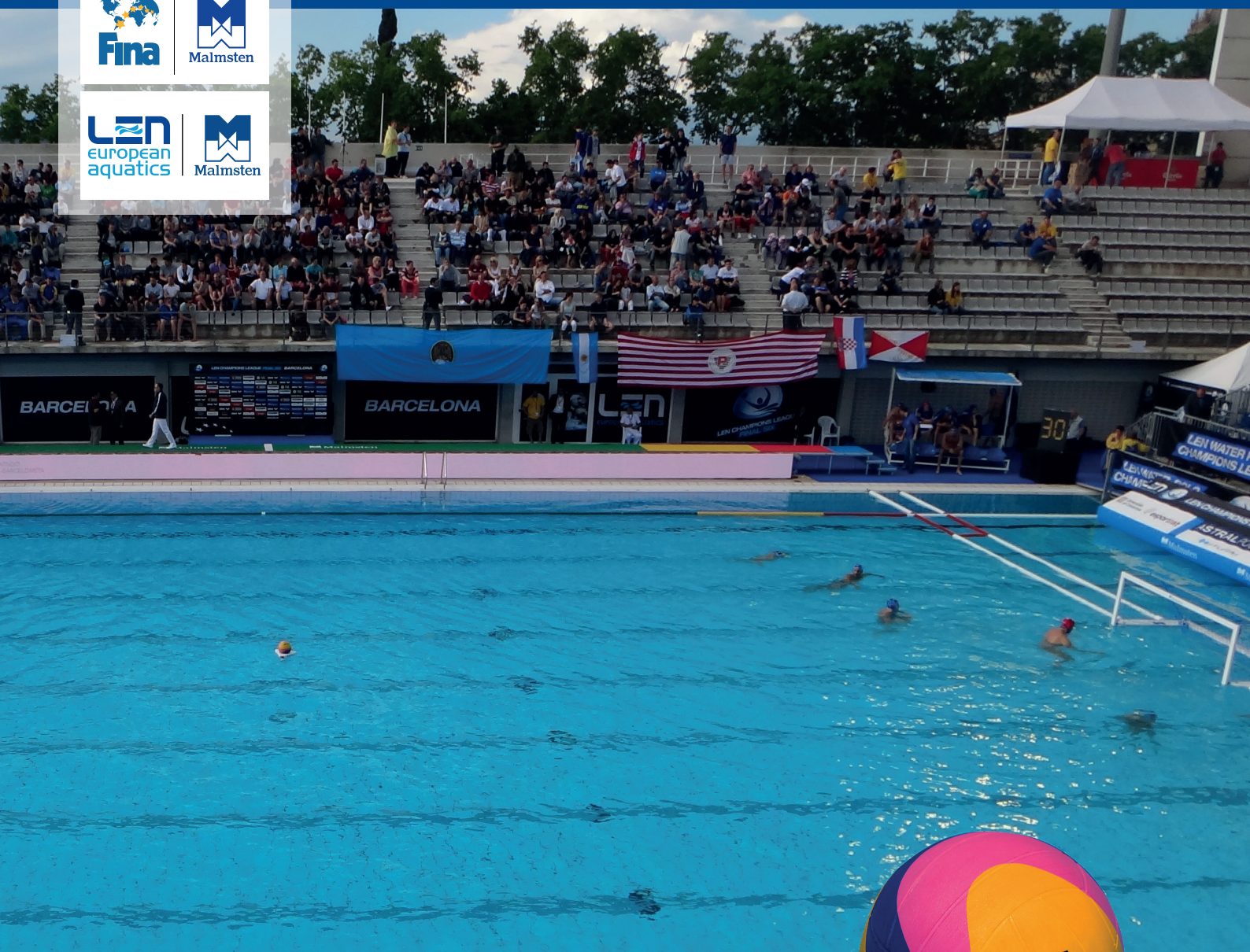

Water Polo Ball Release

The ball release is used for the start of play of water polo matches.

Retained on the half distance line, the ball is put into play when the ball release is submerged by pulling the rope from the side of the pool, allowing for fair and accurate starts every time.

At the start of play as the swimmers approach the ball, the ring is pulled under water and the ball released.

Unique qualities:

- Official FINA
- Fits men, women and junior size Water Polo balls
- Easy to install
- Easy to use



Product description:

EVA foam, high density plastic and stainless steel
 Float made from high density plastic and EVA-foam
 25 m retainer cord equipped with snap hokks for ease of installation

Selected When it Counts

Technical information



In order to use (sold separately)

- Two eyebolts need to be installed at the bottom of the pool
- One pool deck anchor is needed

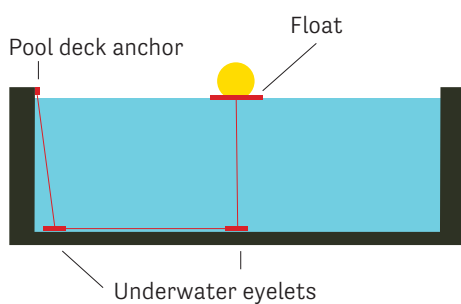

Associated products



1512001 Water Polo Balls
 Herrer W6000, W6000C, W6000W
 Damer W6009, W6009C, W6009W
 Junior
 Mini

Our goal is 100%
 customer
 satisfaction

Malmsten – swimming hall specialists with over 40 years
 experience in the development of swimming pool equipment.
 Explore the full product range at www.malmsten.com

Selected When it Counts



WP Goal 1500 mm - Portable/Inflatable

An affordable and practical water polo goal solution. Made in a strong reinforced PVC with welded hard plastic solid corners.

This goal size is made for ball practice in a smaller area and may be easily affixed between two lane ropes.

Takes only a few minutes to inflate and install. Supplied with a pump and comes in a practical storage bag with handles. In the kit there are also 2 rubber straps with snap hooks for easy installation.

Portable and easy to move and store. Easy to maintain and use.

Unique Qualities:

- Effective ball training: may be placed in between two lane ropes in a smaller swimming pool
- Great for pool, hotels and ocean play
- Portable and easy to move and store
- Easy Quick Inflate / Deflate Valve
- Easy to maintain and use
- Auto Lock Valve System

Product Specifications:

Width 1500 mm

Height: 600 mm

Made of reinforced PVC

Packing size: 500 x 380 x 360 mm; 8 kg

Included:

Sport bag, Medium pump, Repair kit, Back-up valve, 2 Rubber ropes with hook

Our products are non toxic and green for the environment.

Selected When it Counts



WP Goal 2500 mm – Portable/Inflatable

An affordable and practical water polo goal solution. Made in a strong reinforced PVC with welded hard plastic solid corners.

Takes only a few minutes to inflate and install. Supplied with a pump and comes in a practical storage bag with handles. In the kit there are also 2 rubber straps with snap hooks for easy installation.

Portable and easy to move and store.

Official Habawaba U13 and recommended size for beach

Product Specifications:

Width: 2500 mm

Height: 800 mm

Made of reinforced PVC

Packing size: 660 x 410 x 380 mm; 13 kg

Included:

Sport bag, Medium pump, Repair kit,
Back-up valve, 2 Rubber ropes with hook

Our products are non toxic and green for the environment.

Unique Qualities:

- For exercise, play
- Great for Waterpolo Clubs
- Great for pool and ocean play
- Portable and easy to move and store
- Easy Quick Inflate / Deflate Valve
- Easy to maintain and use
- Auto Lock Valve System

Selected When it Counts



WP Goal 2150 mm – Portable/Inflatable

An affordable and practical water polo goal solution. Made in a strong reinforced PVC with welded hard plastic solid corners.

Takes only a few minutes to inflate and install. Supplied with a pump and comes in a practical storage bag with handles. In the kit there are also 2 rubber straps with snap hooks for easy installation.

Portable and easy to move and store.

This is the Official Habawaba U9 and U11.

Unique Qualities:

- FINA and LEN standards
- Great for Waterpolo Clubs
- Great for Pool and Ocean Play
- Portable and easy to move and store
- Easy Quick Inflate / Deflate Valve
- Easy to maintain and use
- Auto Lock Valve System

Product Specifications:

Width: 2150 mm

Height: 750 mm

Made of reinforced PVC

Packing size: 500 x 400 x 370mm; 9,5 kg

Included:

Sport bag, Medium pump, Repair kit,
Back-up valve, 2 Rubber ropes with hook

Our products are non toxic and green for the environment.

Selected When it Counts



Water Polo Goal Malmsten, free floating

Beach/Junior

Identical to our popular senior water polo goal – the Official FINA goal – but beach/junior size.

Free-floating model with reliable frame construction made of aluminum profiles, powder coated yellow and with floating supports in yellow as well. The width of the support ensures a stable and well afloat goal.

This goal suits perfectly for competitions as well as training activities, as it is high quality and easy to handle.

The yellow color makes it perfect for beach activities.

Unique qualities:

- Official FINA water polo goal
- Stable Construction
- Ready to use, as easy as 1-2-3!
- Foldable for ease of storage and transport
- Removable castors for ease of transport and handling
- Quality Pro-Net



Product description:

Width 2500 mm
 Height: 800 mm
 Depth: 1586 mm
 Material: Aluminum
 Powder coated yellow
 Rectangular frame: 75 x 40 mm
 Net included

Selected When it Counts



Associated and alternative products



1514006 Net for Official FINA and Beach/Junior Water Polo Goal



1011023 Spring Cover White



1512001 Water Polo Balls Mikasa
1512002 Water Polo Balls Malmsten



1511003 Water Polo Goal Malmsten, free-floating



1514012 Water Polo Stop net



1514016 Lockable cart for Stop net



1510001 Field Line Water Polo of play



1510002 Goal Line



1510003 Re-entry Demarcation Line



1511002 Water Polo Goal Klappex



1511005 Goal Inflatable Youth



1511006 Junior WP Goal inflatable



Water Polo Goal Malmsten, free-floating

Official FINA – made by Malmsten in Sweden

Popular competition goal and Official product for LEN and FINA. Free-floating model with reliable frame construction made of aluminum profiles, powder painted white and with a floating white support. The width of the support ensures a stable well afloat goal.

This goal suits perfectly for competition as well as training activities, as its high quality and easy to handle.

Faktory assembled. Ready to use.

Unique qualities:

- Official FINA water polo goal
- Stable construction
- Ready to use, as easy as 1-2-3!
- Foldable for ease of storage and transport
- Removable castors for ease of transport and handling
- Quality pro-net



Product description:

Width 3000 mm.
Height: 900 mm.
Depth: 1586 mm.
Material: Aluminum.
Powder painted white
Retangular frame: 80 x 40 mm.
Nets included.

Selected When it Counts

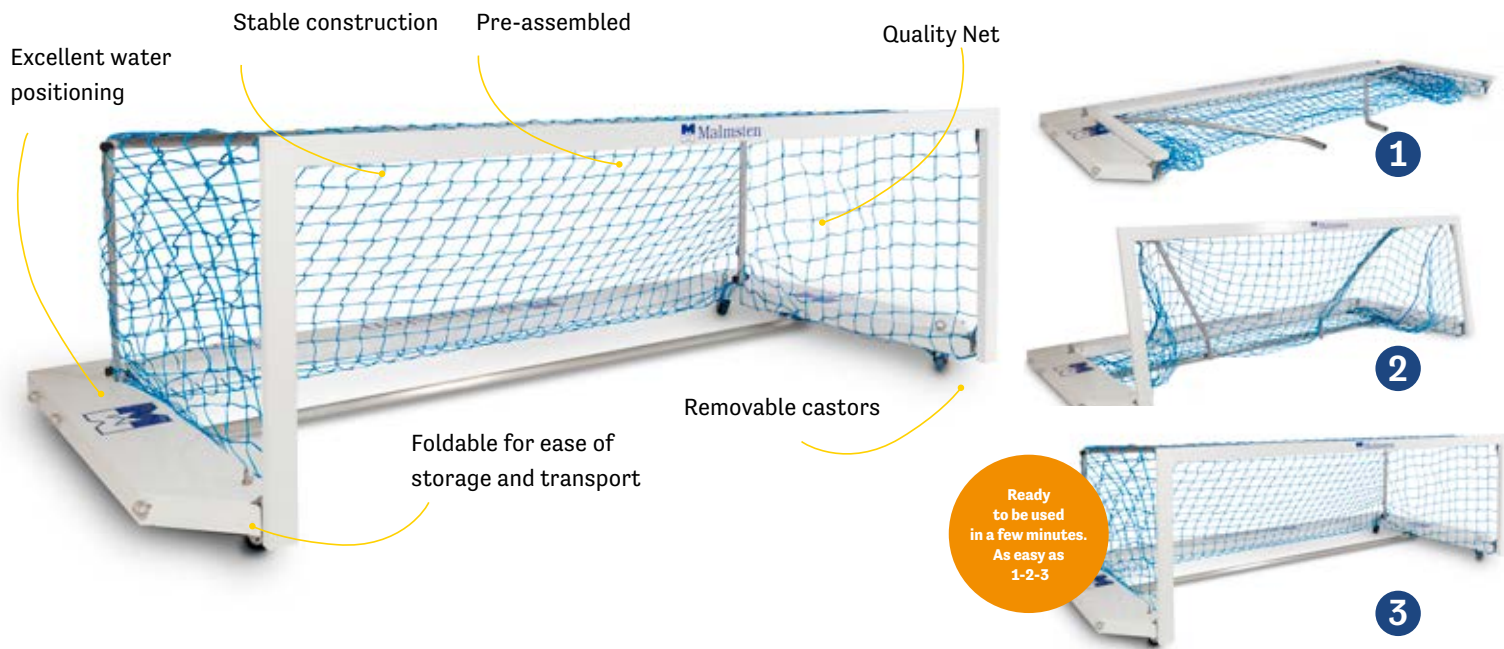

Associated and alternative products



1514006 Net for Official FINA and Beach/Junior Water Polo Goal



1011023 Spring Cover White



1514021 Cones – Water Polo Field Line



1511004 Beach/Junior Water Polo Goal



1514012 Water Polo Stopnet



1514016 Lockable cart for Stopnet



1510001 Field Line of Play



1510002 Goal Line



1510003 Re-entry Demarcation Line



1511002 Water Polo Goal Klappex



1511005 Goal Inflatable Youth



1511006 Junior WP Goal 2500x800 mm inflatable